

The antenna AD-64/A is the ultra wideband manpack antenna intended for use with modern broadband software defined radios (SDR). The antenna is sleeve dipole center fed design thus enable to work without the presence of the ground plane.

Radiation part of the antenna is fully enclosed in a fiberglass radome. The antenna is also equipped with the flexible goose neck allowing the antenna to be bent in almost every position. The antenna construction is rugged and intended for use in the harshest military environments.

Frequency range	225 - 2500 Mhz
Impedance	50 ohms
VSWR	< 3:1 typical (see diagram)
Maximum power	50 W CW
Polarization	Linear Vertical
Gain	see diagram
Radiation Pattern	omnidirectional
Connector	N male
Height	650 mm
Weight	0.55 kg
Radome Diameter	28 mm
Temperature range	- 40....+70 °C

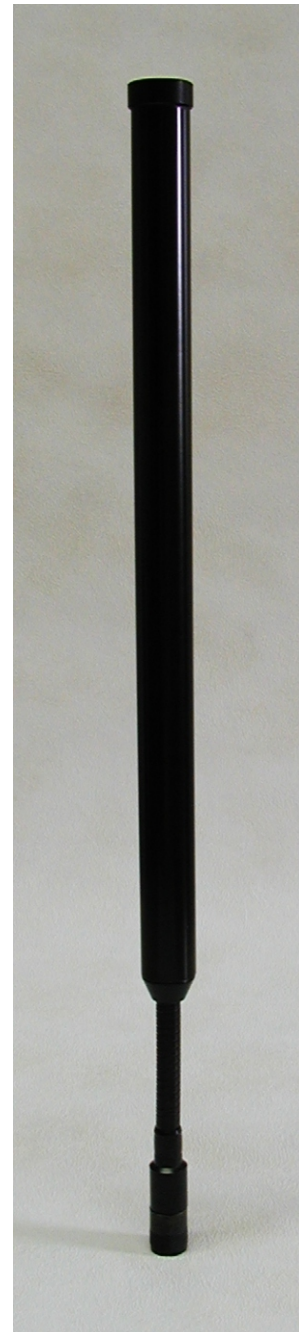

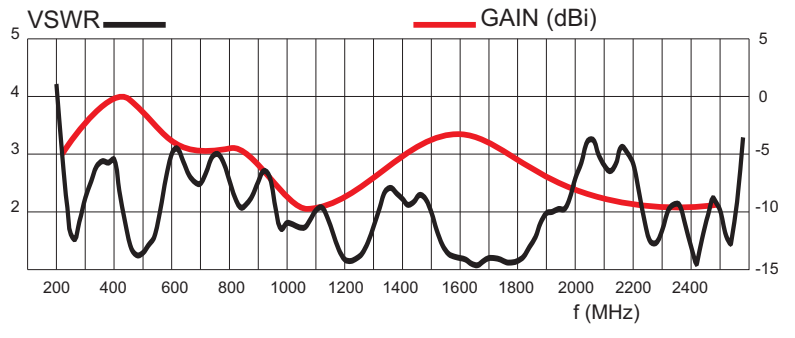
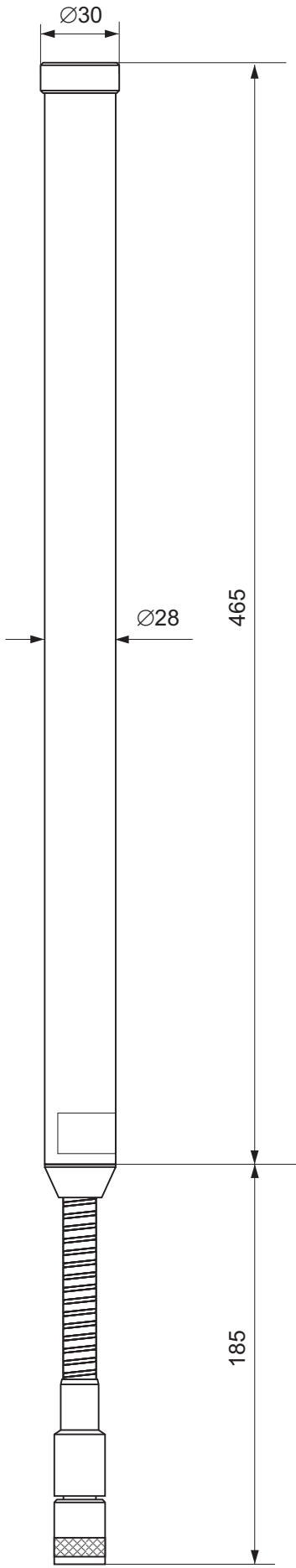

Rad. Pattern E-plane
Frequency: 200 MHz

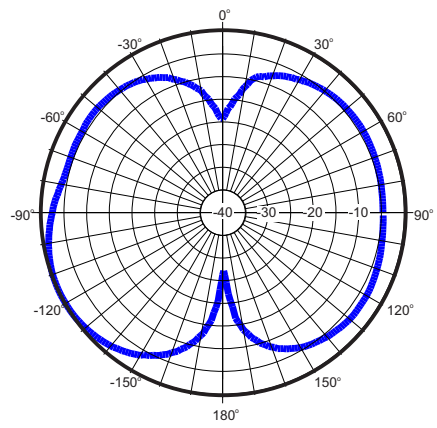

Rad. Pattern E-plane
Frequency: 400 MHz

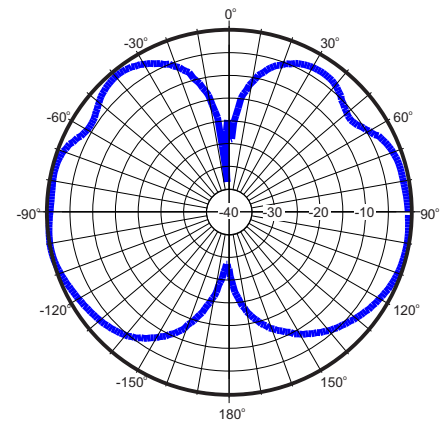

Rad. Pattern E-plane
Frequency: 800 MHz

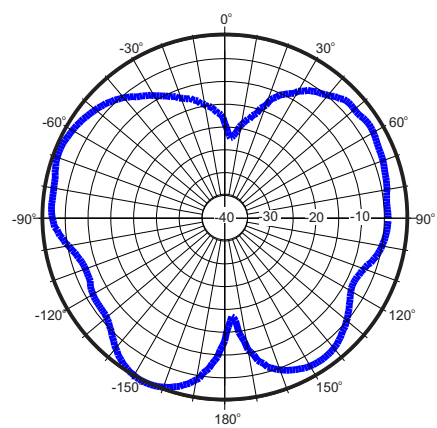

Rad. Pattern E-plane
Frequency: 1400 MHz

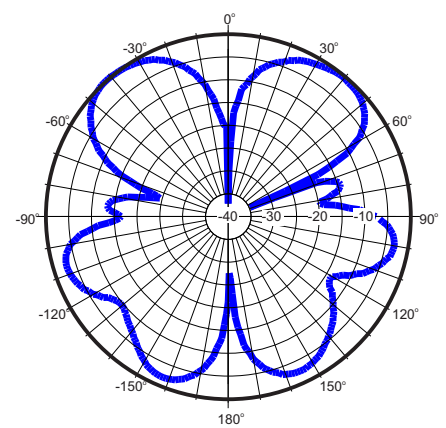

Rad. Pattern E-plane
Frequency: 1800 MHz

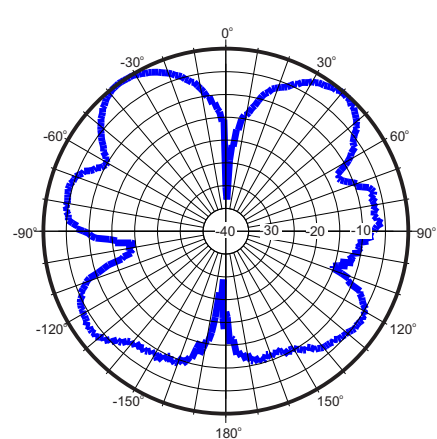

Rad. Pattern E-plane
Frequency: 2000 MHz

